

MODEL CORRELATION FOR IBIS-AMI

Asian IBIS Summit, Shanghai, China, November 14, 2018

Authors:

Wenyan Xie, Guohua Wang, David Zhang, Anders Ekholm

AGENDA



- › Why IBIS-AMI correlation
- › Correlation methodology for TX
- › Correlation methodology for RX
- › Correlation criteria
- › Question and suggestion

AGENDA



- › Why IBIS-AMI correlation
- › Correlation methodology for TX
- › Correlation methodology for RX
- › Correlation criteria
- › Question and suggestion

WHY CORRELATION FOR IBIS-AMI

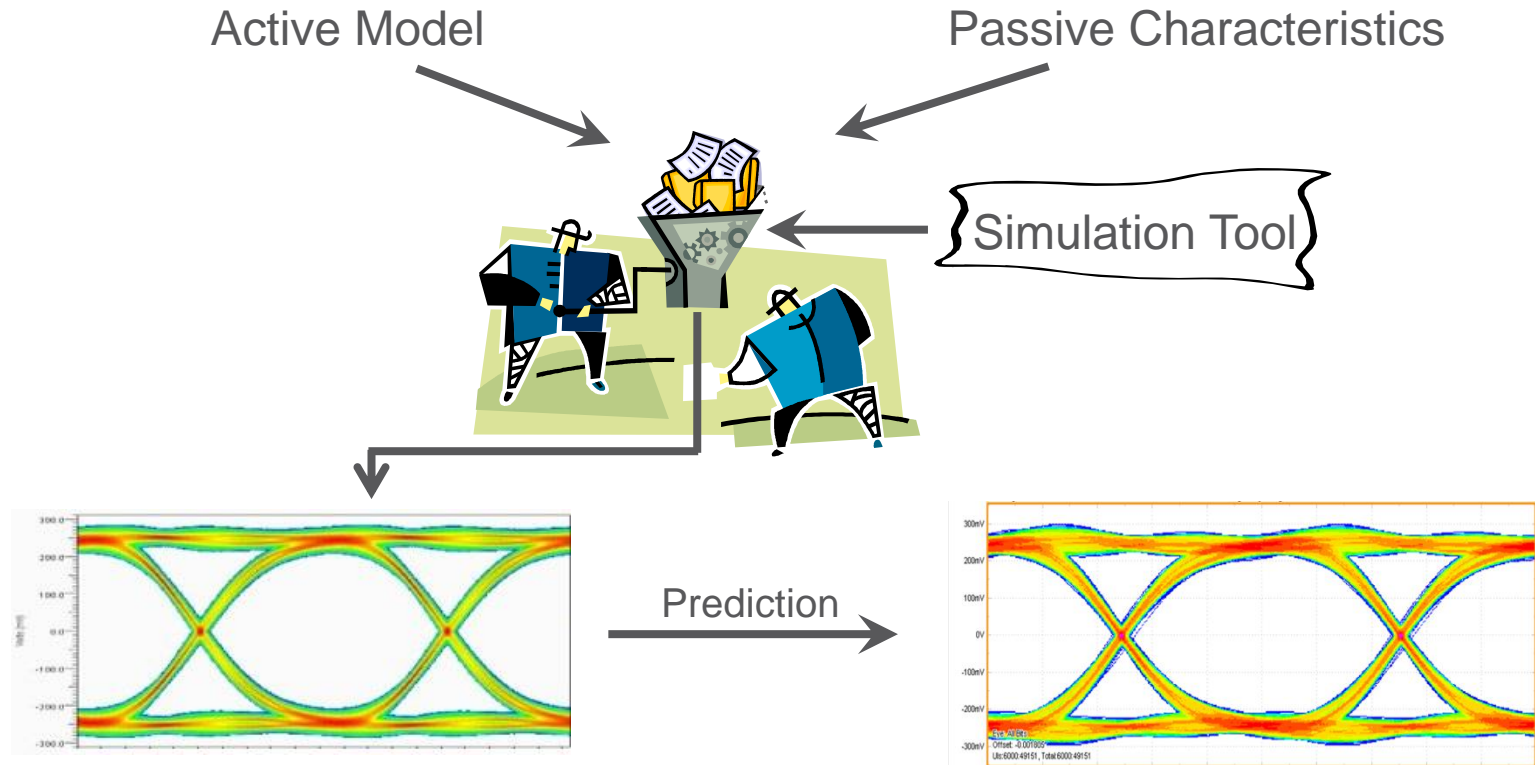

WHY CORRELATION FOR IBIS-AMI



- › Correlation not only can verify simulation model's accuracy, but also can increase the verification coverage once model is matched to real tests. With the correlation, the simulation results can be the part of verification to cover some cases that measurement can not touch.

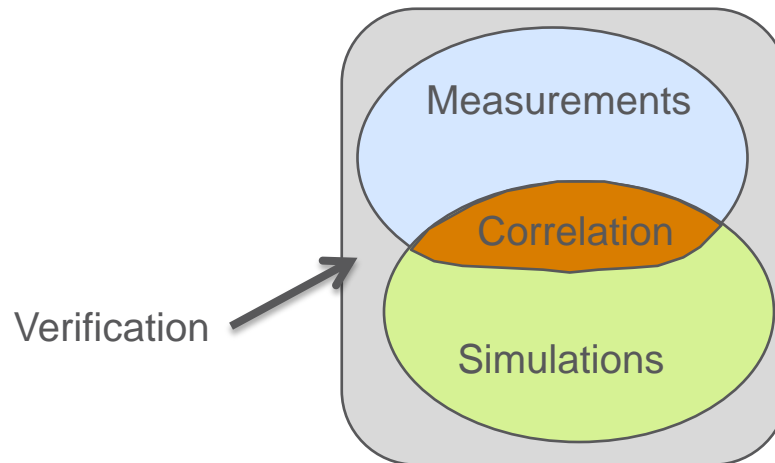

AGENDA



- › Why IBIS-AMI correlation
- › Correlation methodology for TX
- › Correlation methodology for RX
- › Correlation criteria
- › Question and suggestion

CORRELATION METHODOLOGY FOR TX



› Procedure

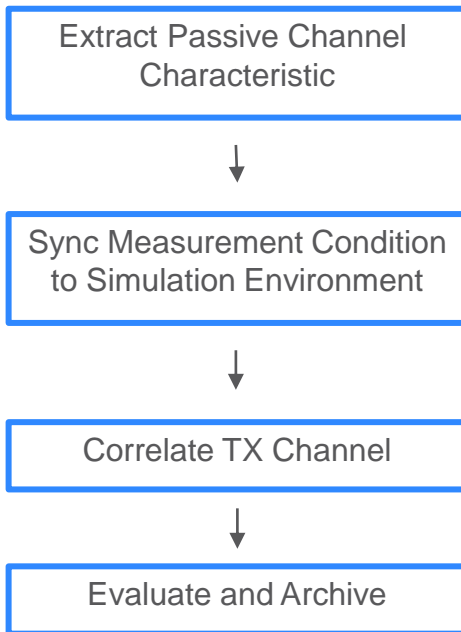

Example

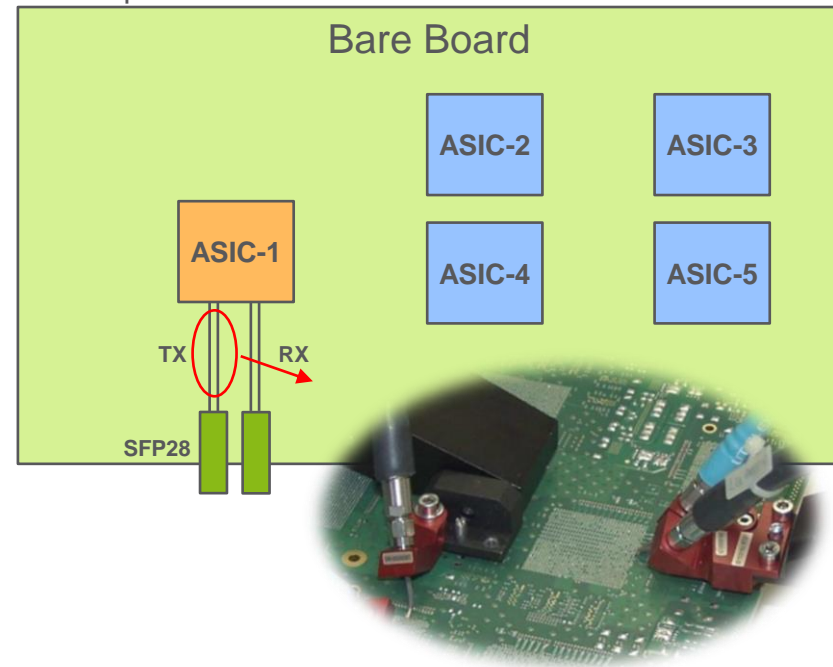

CORRELATION METHODOLOGY FOR TX



› Procedure

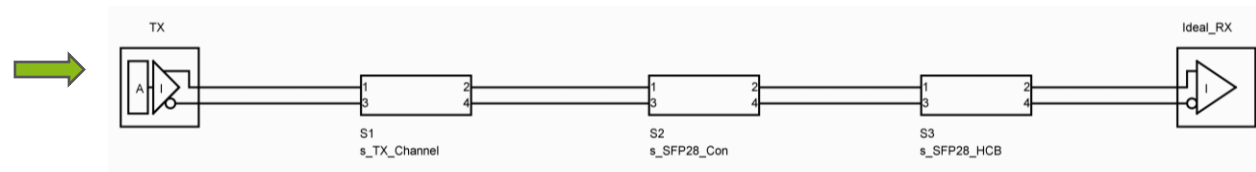
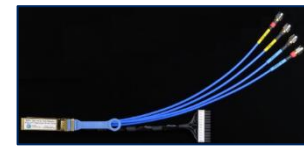
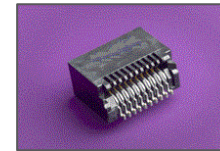
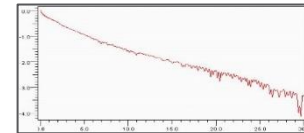
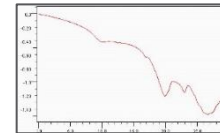
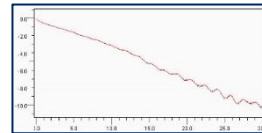
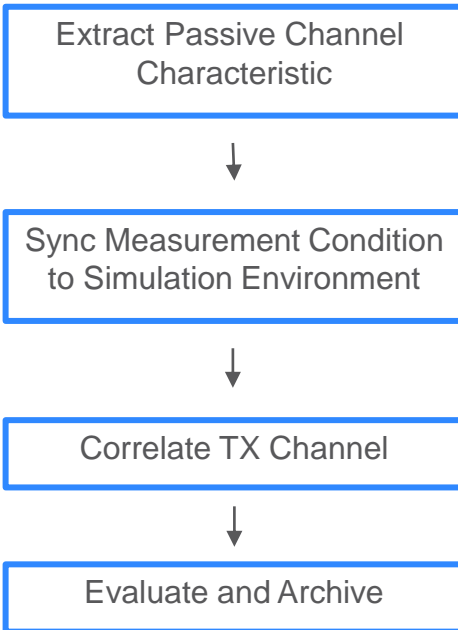

- PVT Settings
- Stimulus patterns
- Running bits
- Samples per bit



CORRELATION METHODOLOGY FOR TX



› Procedure

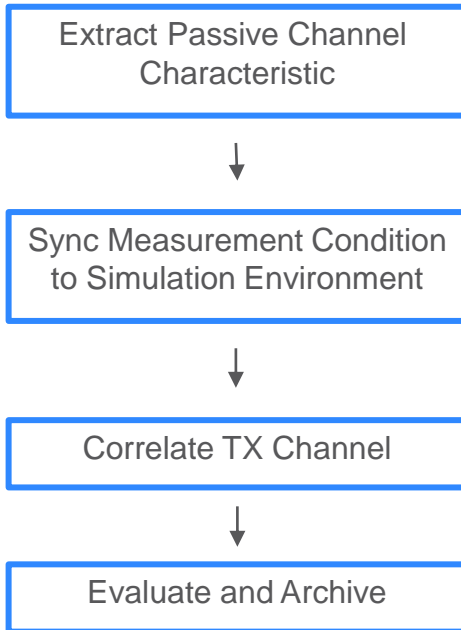

Item	TXDIFFCTRL[3:0]	TXPRECURSOR[4:0]	TXPOSTCURSOR[4:0]	Pattern	Output	Item	TXDIFFCTRL[3:0]	TXPRECURSOR[4:0]	TXPOSTCURSOR[4:0]	Pattern	Output
Case1	0	0	0	slow clock	waveform.csv	Case31	0	0	0	prbs7	waveform.csv&eye diagram
Case2	1	0	0	slow clock	waveform.csv	Case32	1	0	0	prbs7	waveform.csv&eye diagram
Case3	2	0	0	slow clock	waveform.csv	Case33	2	0	0	prbs7	waveform.csv&eye diagram
Case4	3	0	0	slow clock	waveform.csv	Case34	3	0	0	prbs7	waveform.csv&eye diagram
Case5	4	0	0	slow clock	waveform.csv	Case35	4	0	0	prbs7	waveform.csv&eye diagram
Case6	5	0	0	slow clock	waveform.csv	Case36	5	0	0	prbs7	waveform.csv&eye diagram
Case7	6	0	0	slow clock	waveform.csv	Case37	6	0	0	prbs7	waveform.csv&eye diagram
Case8	7	0	0	slow clock	waveform.csv	Case38	7	0	0	prbs7	waveform.csv&eye diagram
Case9	8	0	0	slow clock	waveform.csv	Case39	8	0	0	prbs7	waveform.csv&eye diagram
Case10	9	0	0	slow clock	waveform.csv	Case40	9	0	0	prbs7	waveform.csv&eye diagram
Case11	10	0	0	slow clock	waveform.csv	Case41	10	0	0	prbs7	waveform.csv&eye diagram
Case12	11	0	0	slow clock	waveform.csv	Case42	11	0	0	prbs7	waveform.csv&eye diagram
Case13	12	0	0	slow clock	waveform.csv	Case43	12	0	0	prbs7	waveform.csv&eye diagram
Case14	13	0	0	slow clock	waveform.csv	Case44	13	0	0	prbs7	waveform.csv&eye diagram
Case15	14	0	0	slow clock	waveform.csv	Case45	14	0	0	prbs7	waveform.csv&eye diagram
Case16	15	0	0	slow clock	waveform.csv	Case46	15	0	0	prbs7	waveform.csv&eye diagram
Case17	8	5	0	slow clock	waveform.csv	Case47	8	5	0	prbs7	waveform.csv&eye diagram
Case18	8	10	0	slow clock	waveform.csv	Case48	8	10	0	prbs7	waveform.csv&eye diagram
Case19	8	15	0	slow clock	waveform.csv	Case49	8	15	0	prbs7	waveform.csv&eye diagram
Case20	8	20	0	slow clock	waveform.csv	Case50	8	20	0	prbs7	waveform.csv&eye diagram
Case21	8	0	5	slow clock	waveform.csv	Case51	8	0	5	prbs7	waveform.csv&eye diagram
Case22	8	0	10	slow clock	waveform.csv	Case52	8	0	10	prbs7	waveform.csv&eye diagram
Case23	8	0	15	slow clock	waveform.csv	Case53	8	0	15	prbs7	waveform.csv&eye diagram
Case24	8	0	20	slow clock	waveform.csv	Case54	8	0	20	prbs7	waveform.csv&eye diagram
Case25	8	0	25	slow clock	waveform.csv	Case55	8	0	25	prbs7	waveform.csv&eye diagram
Case26	8	0	31	slow clock	waveform.csv	Case56	8	0	31	prbs7	waveform.csv&eye diagram
Case27	8	5	5	slow clock	waveform.csv	Case57	8	5	5	prbs7	waveform.csv&eye diagram
Case28	8	5	10	slow clock	waveform.csv	Case58	8	5	10	prbs7	waveform.csv&eye diagram
Case29	8	10	5	slow clock	waveform.csv	Case59	8	10	5	prbs7	waveform.csv&eye diagram
Case30	8	10	10	slow clock	waveform.csv	Case60	8	10	10	prbs7	waveform.csv&eye diagram

CORRELATION RESULTS FOR TX



› Slow Clock Pattern – Edge and Amplitude Voltage

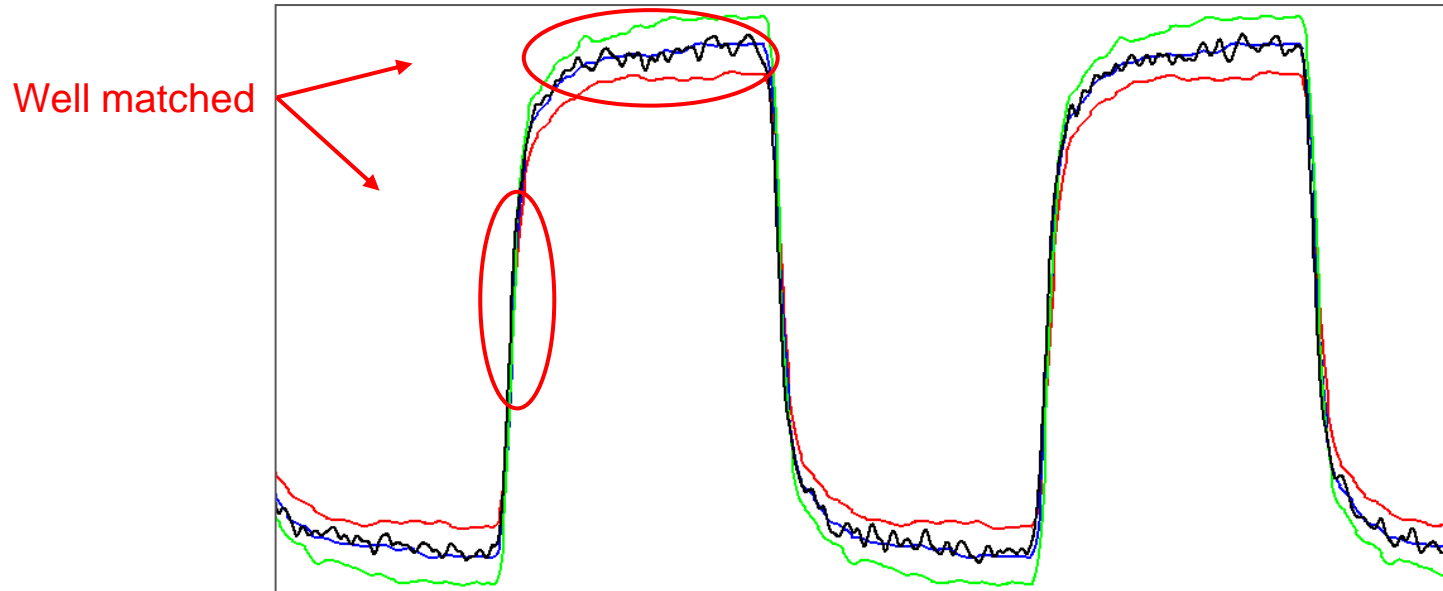

CORRELATION RESULTS FOR TX



› Slow Clock Pattern – FFE Taps

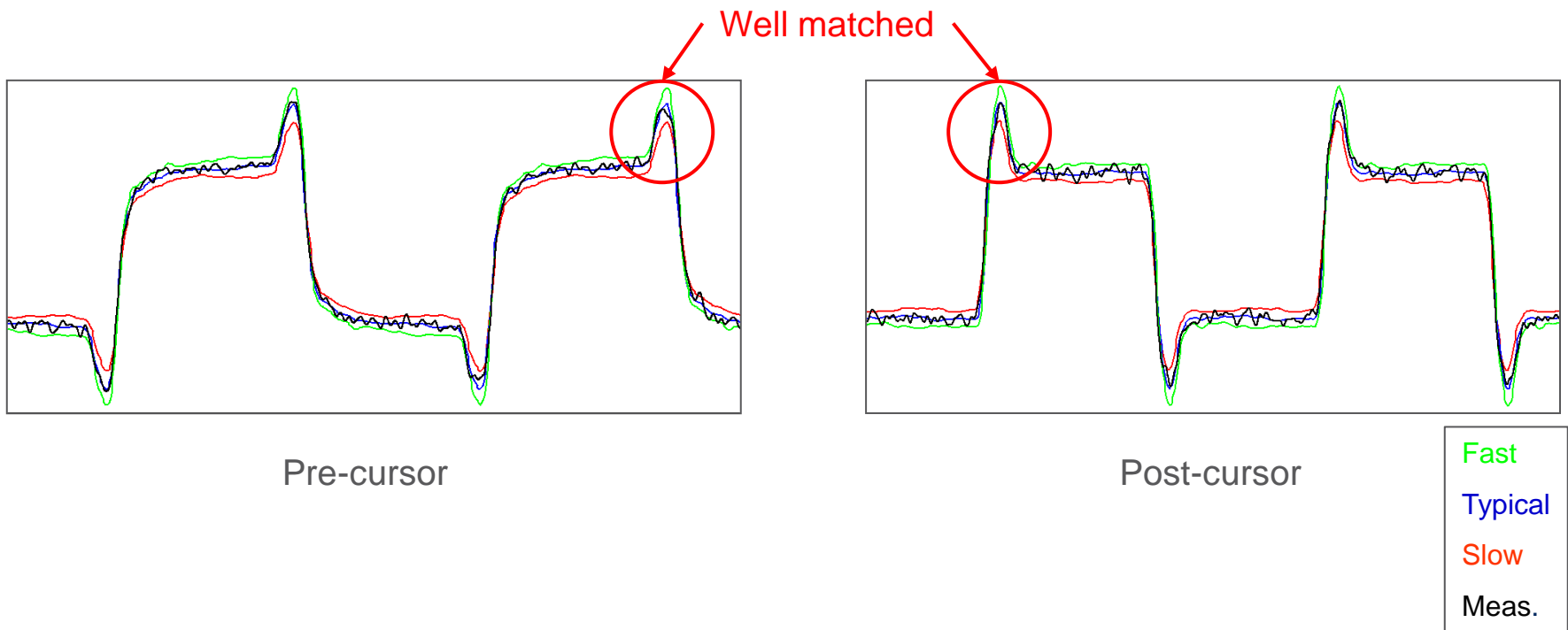

CORRELATION RESULTS FOR TX



› PRBS7 Pattern – Fast Response

Well matched

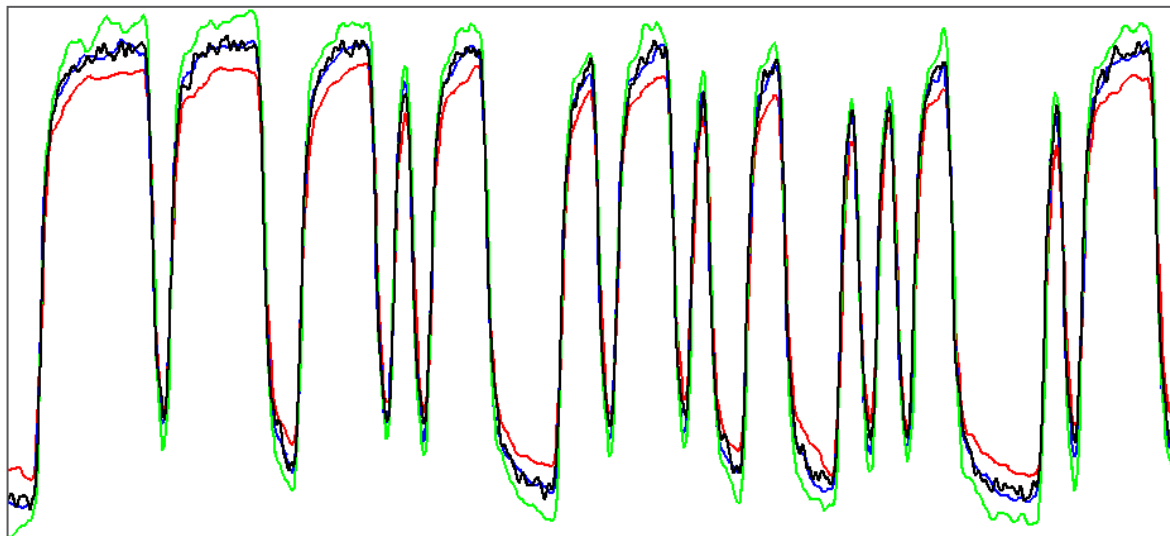

TREND CORRELATION FOR TAP



› Time Domain Eye Height – Precursor Sweep

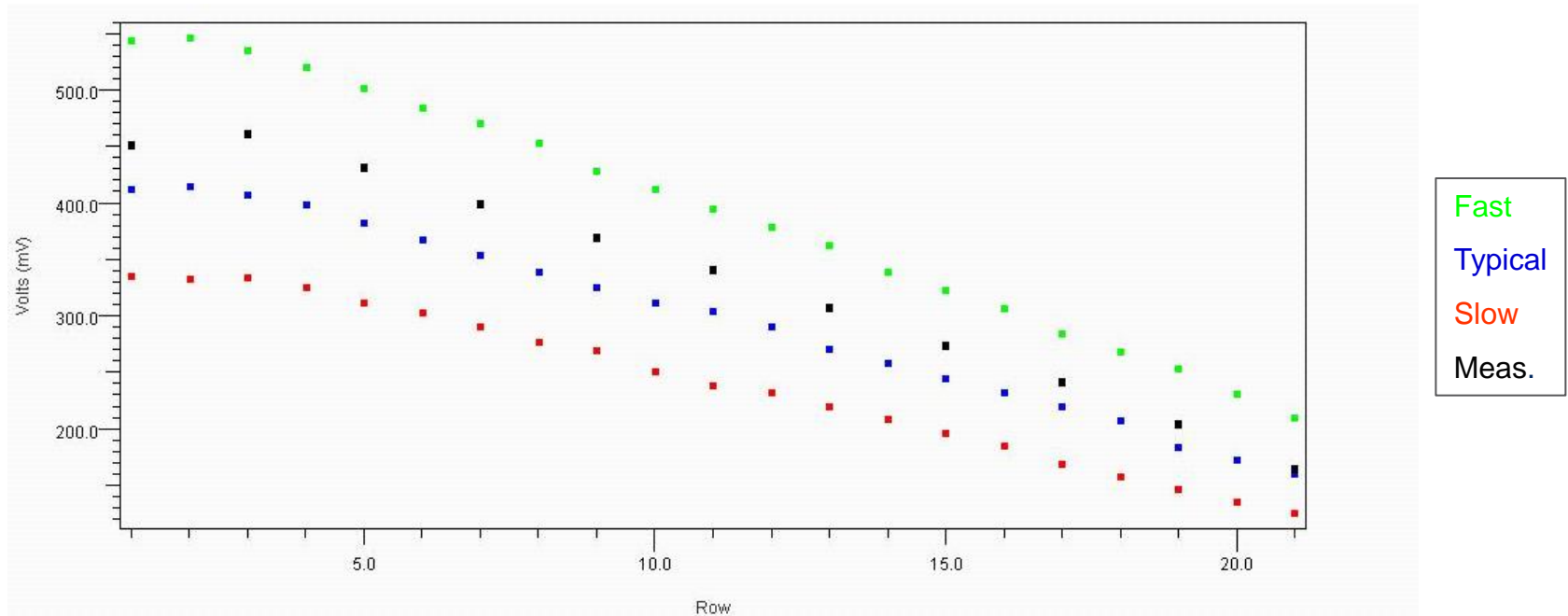

TREND CORRELATION FOR TAP



› Time Domain Eye Width – Precursor Sweep

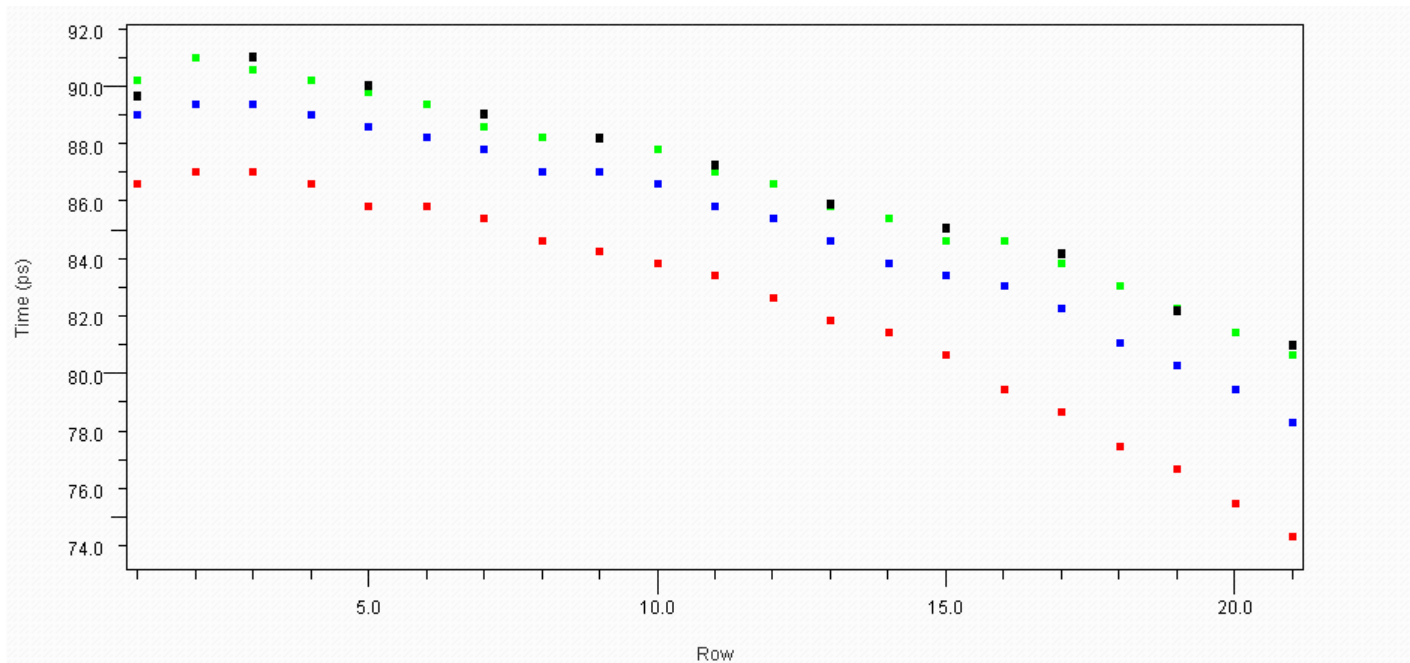

TREND CORRELATION FOR TAP



› Time Domain Eye Height – Postcursor Sweep

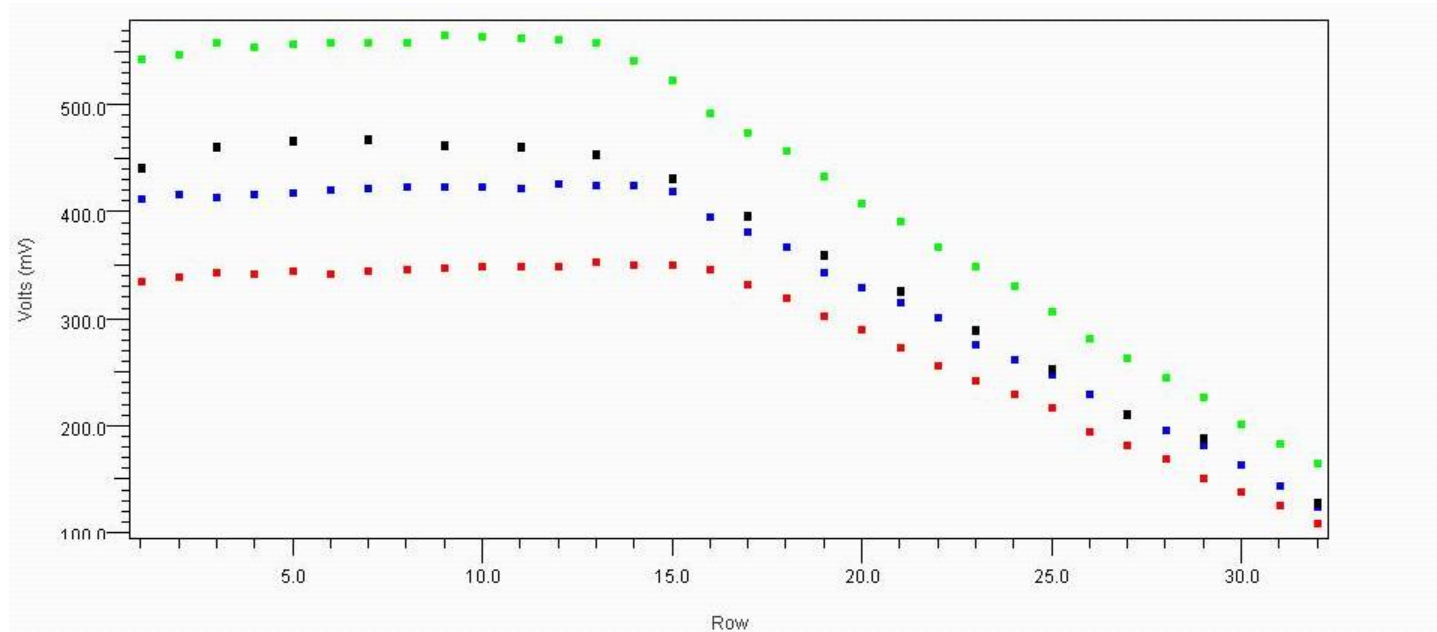

TREND CORRELATION FOR TAP



› Time Domain Eye Width – Postcursor Sweep

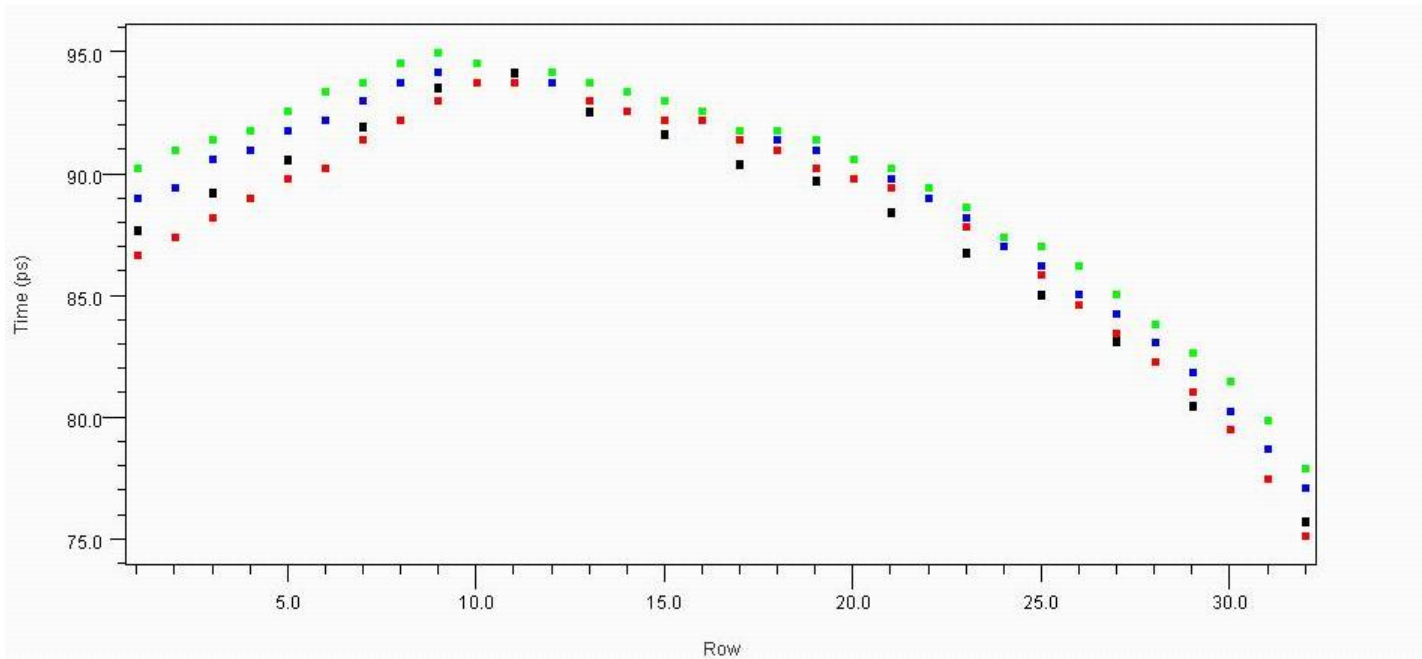

AGENDA



- › Why IBIS-AMI correlation
- › Correlation methodology for TX
- › Correlation methodology for RX
- › Correlation criteria
- › Question and suggestion for

CORRELATION METHODOLOGY FOR RX



› Procedure

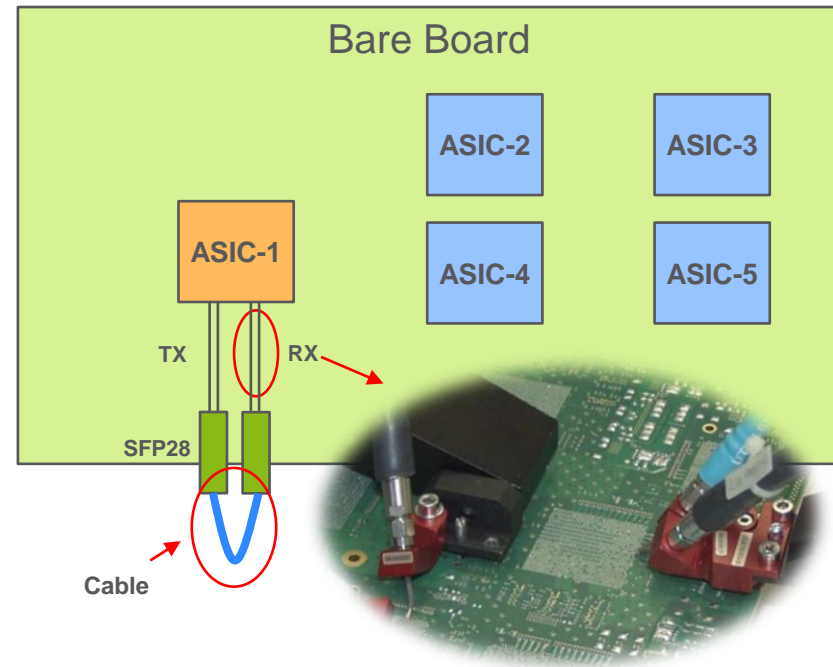
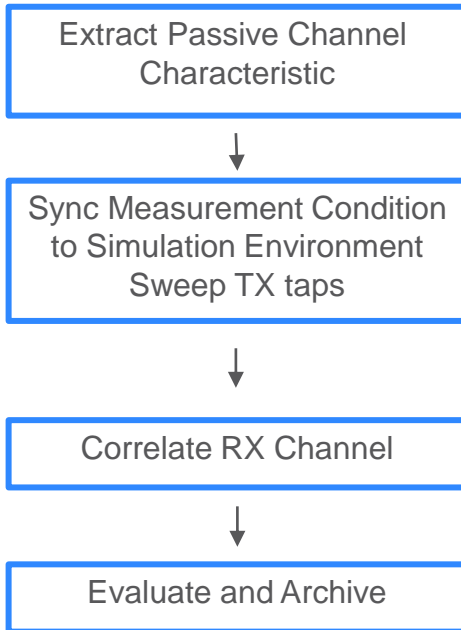

CORRELATION METHODOLOGY FOR RX



› Procedure

Extract Passive Channel Characteristic



Sync Measurement Condition to Simulation Environment
Sweep TX taps



Correlate RX Channel



Evaluate and Archive



- Cable Length:
 - 0.6m
 - 1.0m
 - 1.8m
 - 3.0m
 - 5.0m

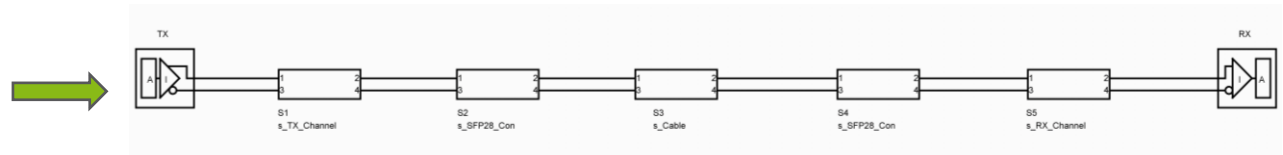

- PVT Settings
- Stimulus patterns
- Running bits
- Samples per bit
- Taps sweep

- RX CTLE adapt
- RX CTLE and DFE adapt

CORRELATION METHODOLOGY FOR RX



› Procedure

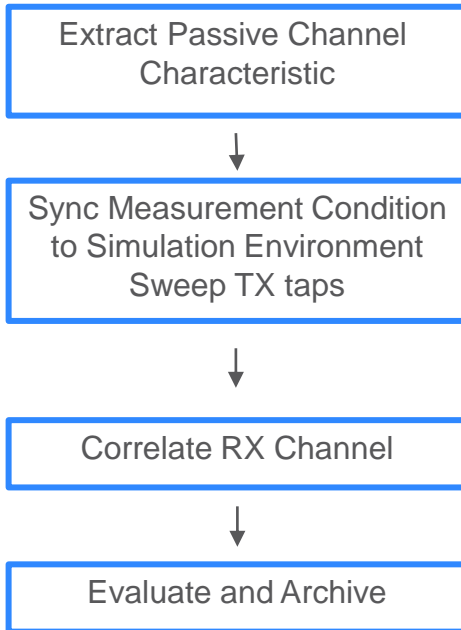

Item	TXDIFFCTRL[3:0]	TXPRECURSOR[4:0]	TXPOSTCURSOR[4:0]	RX Equalization	Pattern	Output
Case1	8	0	0	CTLE Adapt Only	prbs7	Internal eye
Case2	8	5	0	CTLE Adapt Only	prbs7	Internal eye
Case3	8	10	0	CTLE Adapt Only	prbs7	Internal eye
Case4	8	15	0	CTLE Adapt Only	prbs7	Internal eye
Case5	8	20	0	CTLE Adapt Only	prbs7	Internal eye
Case6	8	0	5	CTLE Adapt Only	prbs7	Internal eye
Case7	8	0	10	CTLE Adapt Only	prbs7	Internal eye
Case8	8	0	15	CTLE Adapt Only	prbs7	Internal eye
Case9	8	0	20	CTLE Adapt Only	prbs7	Internal eye
Case10	8	0	25	CTLE Adapt Only	prbs7	Internal eye
Case11	8	0	31	CTLE Adapt Only	prbs7	Internal eye
Case12	8	5	5	CTLE Adapt Only	prbs7	Internal eye
Case13	8	5	10	CTLE Adapt Only	prbs7	Internal eye
Case14	8	10	5	CTLE Adapt Only	prbs7	Internal eye
Case15	8	10	10	CTLE Adapt Only	prbs7	Internal eye
Case16	8	0	0	DFE&CTLE Adapt	prbs7	Internal eye
Case17	8	5	0	DFE&CTLE Adapt	prbs7	Internal eye
Case18	8	10	0	DFE&CTLE Adapt	prbs7	Internal eye
Case19	8	15	0	DFE&CTLE Adapt	prbs7	Internal eye
Case20	8	20	0	DFE&CTLE Adapt	prbs7	Internal eye
Case21	8	0	5	DFE&CTLE Adapt	prbs7	Internal eye
Case22	8	0	10	DFE&CTLE Adapt	prbs7	Internal eye
Case23	8	0	15	DFE&CTLE Adapt	prbs7	Internal eye
Case24	8	0	20	DFE&CTLE Adapt	prbs7	Internal eye
Case25	8	0	25	DFE&CTLE Adapt	prbs7	Internal eye
Case26	8	0	31	DFE&CTLE Adapt	prbs7	Internal eye
Case27	8	5	5	DFE&CTLE Adapt	prbs7	Internal eye
Case28	8	5	10	DFE&CTLE Adapt	prbs7	Internal eye
Case29	8	10	5	DFE&CTLE Adapt	prbs7	Internal eye
Case30	8	10	10	DFE&CTLE Adapt	prbs7	Internal eye

- Sweep Cable Length:
 - 0.6m
 - 1.0m
 - 1.8m
 - 3.0m
 - 5.0m

CORRELATION WITH INTERNAL EYE



› Now scanning RX internal eye with different TX tap settings

Run	Link	Link Settings	Scan Type	Status	Progress	Open Area	Hor. Insn	Max Range	Vert Insn	Vert Range	Swath	Swath BEZ	Swath Time	Start Time	End Time
Scan 3	Link 3	24_Full_eye	Done			1008 3584	8	-0.500 Hz to 0.500 Hz	+	1008	+	HEB	1+9	-	0.2016-04-27 08:53:11 2016-04-27 08:53:38
Scan 4	Link 4	24_Full_eye	Done			1008 3594	8	-0.500 Hz to 0.500 Hz	+	1008	+	HEB	1+9	-	0.2016-04-27 08:54:09 2016-04-27 08:54:37
Scan 5	Link 5	24_Full_eye	Done			1008 3580	8	-0.500 Hz to 0.500 Hz	+	1008	+	HEB	1+9	-	0.2016-04-27 08:54:40 2016-04-27 08:55:11
Scan 6	Link 6	24_Full_eye	Done			1008 3136	8	-0.500 Hz to 0.500 Hz	+	1008	+	HEB	1+9	-	0.2016-04-27 08:55:14 2016-04-27 08:56:43
Scan 7	Link 7	24_Full_eye	Done			1008 3200	8	-0.500 Hz to 0.500 Hz	+	1008	+	HEB	1+9	-	0.2016-04-27 08:55:44 2016-04-27 08:56:10
Scan 8	Link 8	24_Full_eye	Done			1008 3520	8	-0.500 Hz to 0.500 Hz	+	1008	+	HEB	1+9	-	0.2016-04-27 08:56:13 2016-04-27 08:56:40
Scan 9	Link 9	24_Full_eye	Done			1008 3264	8	-0.500 Hz to 0.500 Hz	+	1008	+	HEB	1+9	-	0.2016-04-27 08:56:42 2016-04-27 08:57:09
Scan 10	Link 10	24_Full_eye	Done			1008 3264	8	-0.500 Hz to 0.500 Hz	+	1008	+	HEB	1+9	-	0.2016-04-27 08:57:10 2016-04-27 08:57:37
Scan 11	Link 11	24_Full_eye	Done			1008 2916	8	-0.500 Hz to 0.500 Hz	+	1008	+	HEB	1+9	-	0.2016-04-27 08:57:35 2016-04-27 08:57:59
Scan 12	Link 12	24_Full_eye	Done			1008 3776	8	-0.500 Hz to 0.500 Hz	+	1008	+	HEB	1+9	-	0.2016-04-27 08:58:03 2016-04-27 08:58:30
Scan 13	Link 13	24_Full_eye	Done			1008 3660	8	-0.500 Hz to 0.500 Hz	+	1008	+	HEB	1+9	-	0.2016-04-27 08:58:39 2016-04-27 08:59:12
Scan 14	Link 14	24_Full_eye	Done			1008 3004	8	-0.500 Hz to 0.500 Hz	+	1008	+	HEB	1+9	-	0.2016-04-27 08:59:14 2016-04-27 08:59:46
Scan 15	Link 15	24_Full_eye	Done			1008 4188	8	-0.500 Hz to 0.500 Hz	+	1008	+	HEB	1+9	-	0.2016-04-27 08:59:49 2016-04-27 09:00:23
Scan 16	Link 16	24_Full_eye	Done			1008 2432	8	-0.500 Hz to 0.500 Hz	+	1008	+	HEB	1+9	-	0.2016-04-27 09:00:27 2016-04-27 09:00:51
Scan 17	Link 17	24_Full_eye	Done			1008 4080	8	-0.500 Hz to 0.500 Hz	+	1008	+	HEB	1+9	-	0.2016-04-27 09:00:53 2016-04-27 09:01:25
Scan 18	Link 18	24_Full_eye	Done			1008 3840	8	-0.500 Hz to 0.500 Hz	+	1008	+	HEB	1+9	-	0.2016-04-27 09:01:28 2016-04-27 09:02:00
Scan 19	Link 19	24_Full_eye	Done			1008 3888	8	-0.500 Hz to 0.500 Hz	+	1008	+	HEB	1+9	-	0.2016-04-27 09:01:34 2016-04-27 09:02:06
Scan 20	Link 20	24_Full_eye	Done			1008 3120	8	-0.500 Hz to 0.500 Hz	+	1008	+	HEB	1+9	-	0.2016-04-27 09:02:32 2016-04-27 09:03:00
Scan 21	Link 21	24_Full_eye	Done			1008 3084	8	-0.500 Hz to 0.500 Hz	+	1008	+	HEB	1+9	-	0.2016-04-27 09:03:02 2016-04-27 09:03:31
Scan 22	Link 22	24_Full_eye	Done			1008 3928	8	-0.500 Hz to 0.500 Hz	+	1008	+	HEB	1+9	-	0.2016-04-27 09:03:32 2016-04-27 09:04:02
Scan 23	Link 23	24_Full_eye	Done			1008 3128	8	-0.500 Hz to 0.500 Hz	+	1008	+	HEB	1+9	-	0.2016-04-27 09:04:10 2016-04-27 09:04:54
Scan 24	Link 24	24_Full_eye	Done			1008 4108	8	-0.500 Hz to 0.500 Hz	+	1008	+	HEB	1+9	-	0.2016-04-27 09:04:50 2016-04-27 09:05:31
Scan 25	Link 1	24_Full_eye	Done			1008 0	8	-0.500 Hz to 0.500 Hz	+	1008	+	HEB	1+9	-	0.2016-04-27 09:08:00 2016-04-27 09:08:09
Scan 26	Link 2	24_Full_eye	Done			1008 4872	8	-0.500 Hz to 0.500 Hz	+	1008	+	HEB	1+9	-	0.2016-04-27 09:09:57 2016-04-27 09:09:32

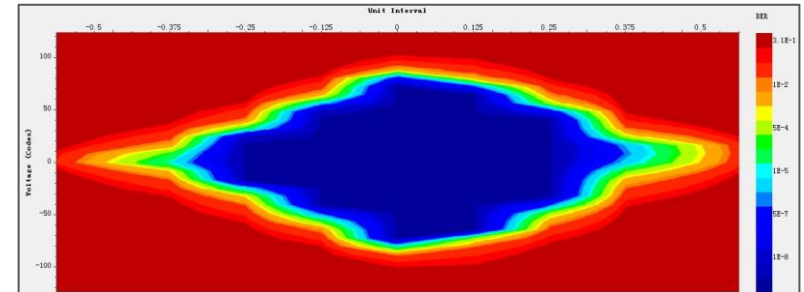

CORRELATION RESULTS FOR RX



› Trend Correlation – Time Domain Eye Height

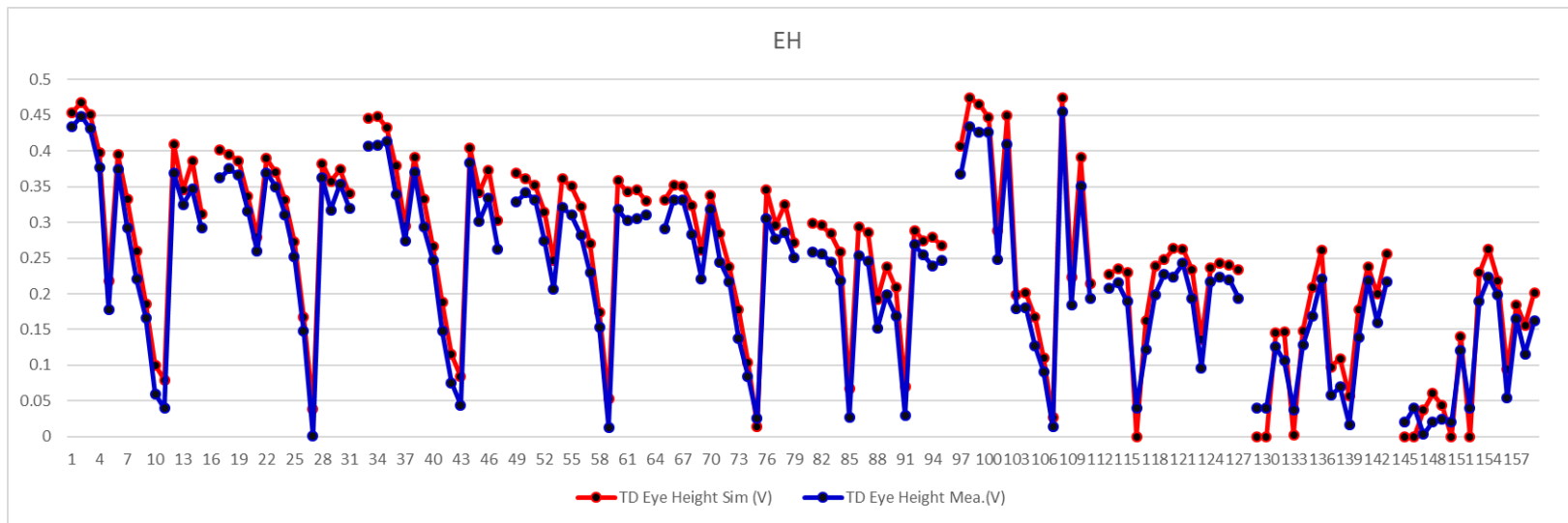

CORRELATION RESULTS FOR RX



› Trend Correlation – Time Domain Eye Width

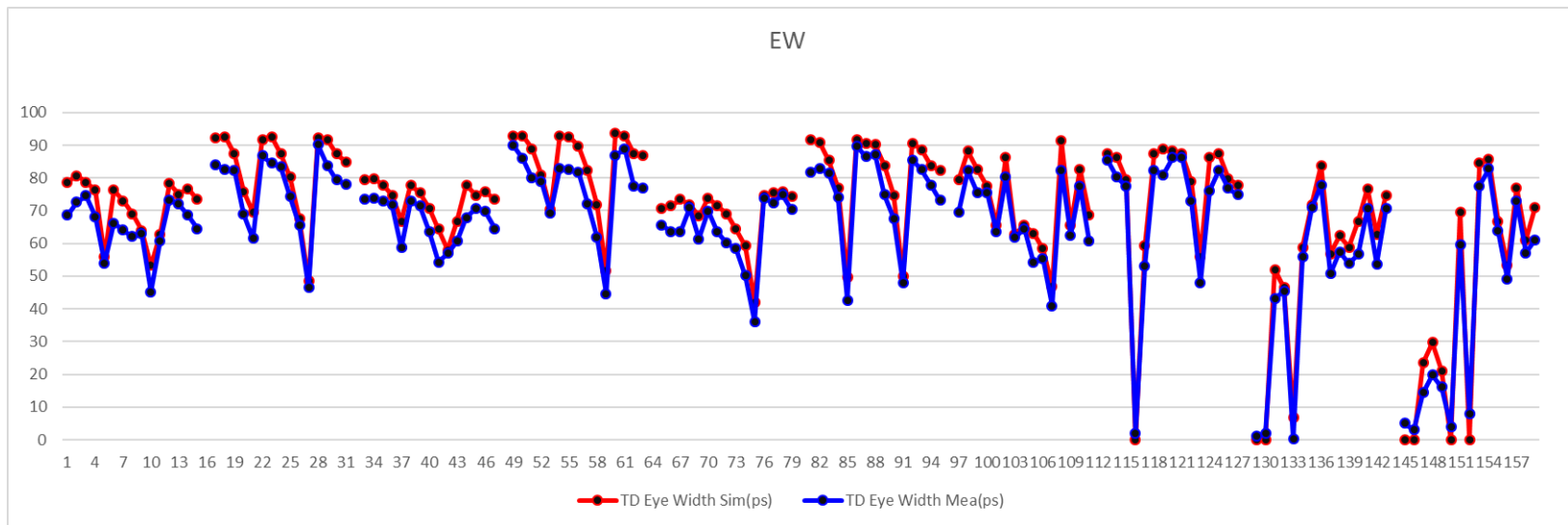

AGENDA



- › Why IBIS-AMI correlation
- › Correlation methodology for TX
- › Correlation methodology for RX
- › Correlation criteria
- › Question and suggestion for

CORRELATION CRITERIA



› Figure of Merit (FOM)

$$FOM = 100 \cdot \left[1 - \frac{\sum_{i=1}^N |X_i(\text{golden}) - X_i(\text{DUT})|}{\Delta X \cdot N} \right]$$

FOM Value	Qualitative Metric
> 99%	Excellent
> 95%	Very Good
> 90%	Good
< 90%	Poor

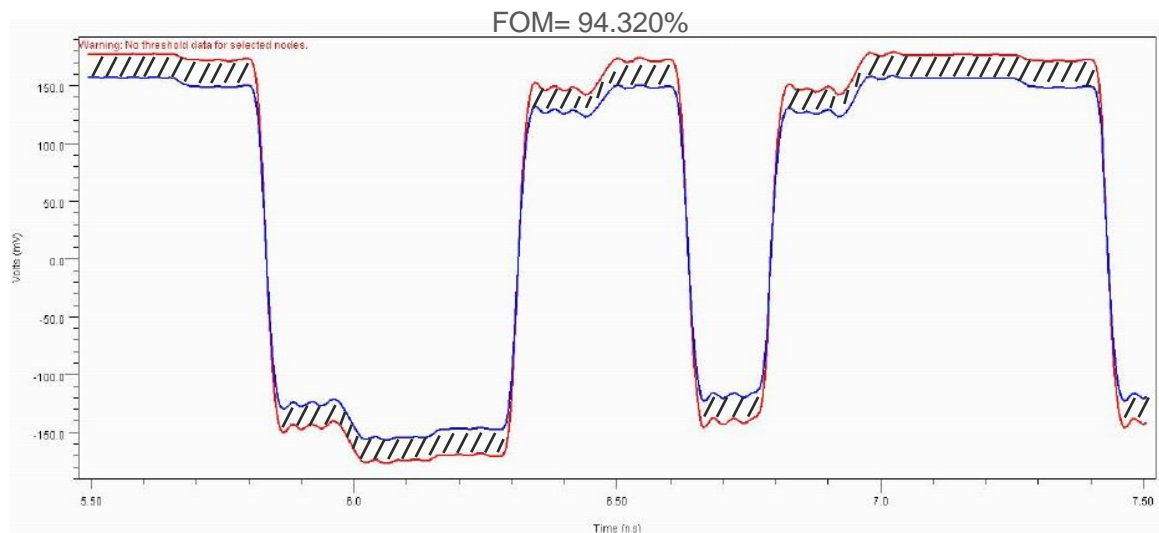

CORRELATION CRITERIA



› Feature Selective Validation (FSV)

The Feature Selective Validation (FSV) method is one of the candidate techniques for the **quantitative validation** of computational electromagnetics (CEM), particularly within electromagnetic compatibility (EMC) and Signal Integrity (SI).

It is based on the decomposition of the original data into two parts: **amplitude (ADM) data** and **feature data(FDM)**. The former will account for the slowly varying data across the data set and the latter will account for the sharp peaks and troughs.

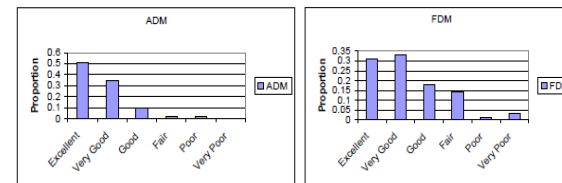

FSV value (quantitative)	FSV interpretation (qualitative)
Less than 0.1	Excellent
Between 0.1 and 0.2	Very good
Between 0.2 and 0.4	Good
Between 0.4 and 0.8	Fair
Between 0.8 and 1.6	Poor
Greater than 1.6	Very poor

Reference

1. Roy Leventhal, "Correlation of Model Simulations and Measurements", Leventhal Design & Communications Presented June 5, 2007 IBIS Summit Meeting, San Diego, California
2. D.Di Febo, F.de Paulis, A.Orlandi "Feature Selective Validation- A new approach for new Engineers" European IBIS Summit Naples, May11, 2011

CORRELATION CRITERIA



› More metrics to correlate

- Besides 5 metrics “high level, low level, rise time, fall time, and duty cycle”, more metrics are necessary: slew rate, cursor pillars..and the metrics should have different weight in final score calculation.

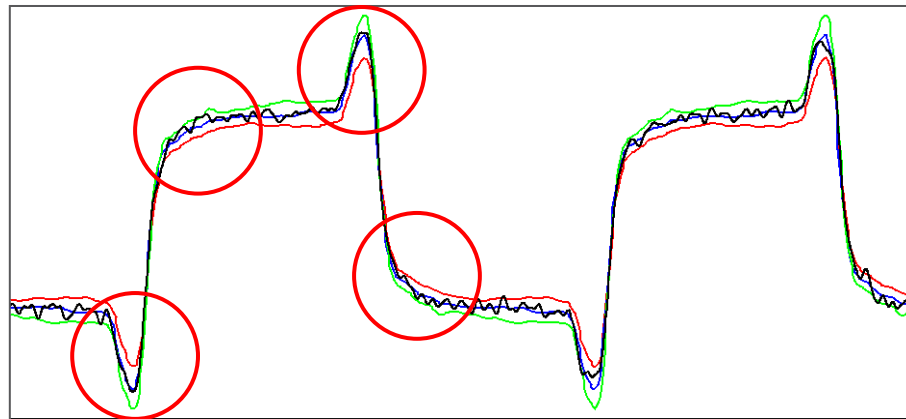

Reference

1. David Banas, “IBIS-to-Spice Correlation a story of 5 metrics”, Presented June 5, 2007 IBIS Summit San Diego, California

AGENDA



- › Why IBIS-AMI correlation
- › Correlation methodology for TX
- › Correlation methodology for RX
- › Correlation criteria
- › Question and suggestion

QUESTION AND SUGGESTION



- › In the paper, Measurement is on Typical corner. No Fast and Slow corners measurement data. So, Can we trust the Fast and Slow corners simulation data, even though Typical correlates very well?
How much do the corners of AMI model match the real silicon's behavior? 99.99%...? It is a statistical problem.

- › We need to introduce the statistical distribution for Fast/Typical/Slow corners of IBIS.

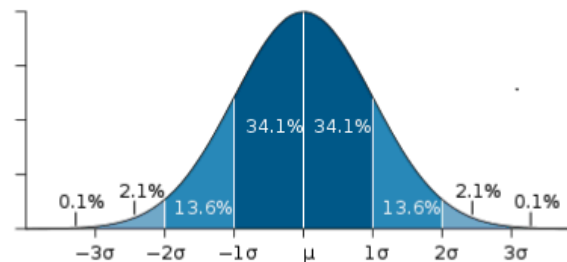
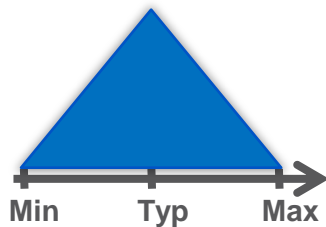

- › We need more metrics for correlation evaluation. Some are proposed in this paper.



ERICSSON